

SALES & ENGINEERING DATA

SB30X-XXX-X SHOCK BLOCKER® 3" METALLIC PULSATION DAMPENER

RATIO
SERIES:

FLUID P.S.I.
RANGE: **20 - 120**

RELEASED: 6-1-00
REVISED: 6-10-10
(REV. E) S-1081

DIMENSIONAL DATA

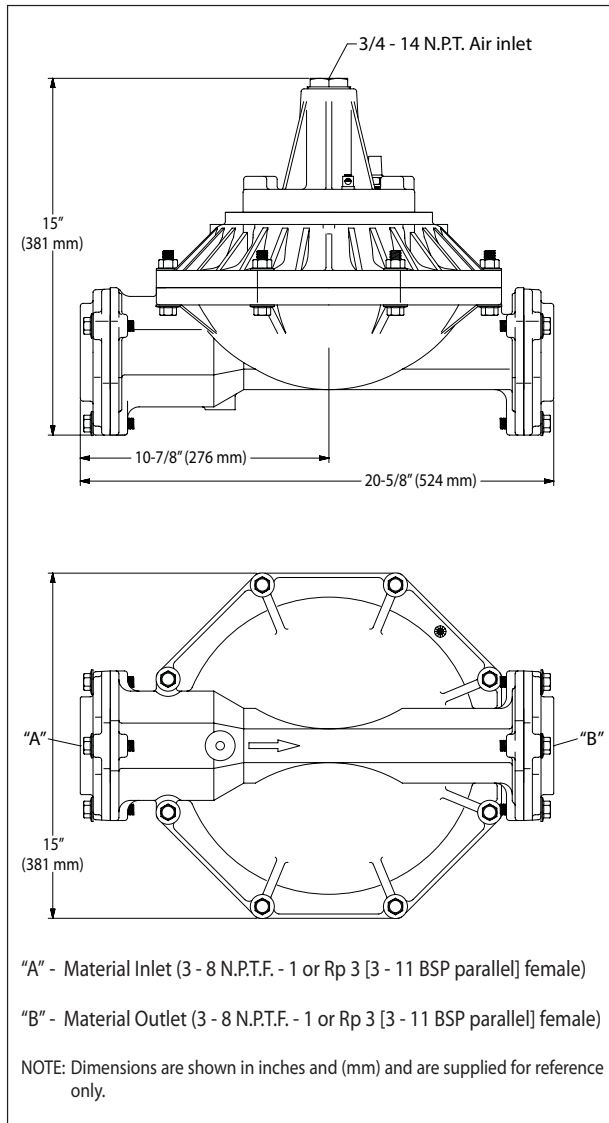

SPECIFICATIONS

CONSTRUCTION

Model Series	SB30X-XXX-X
Pulsation Dampener Type	Metallic
Material Inlet / Outlet	
SB30X- <u>A</u> XX-X	3 - 8 N.P.T.F. - 1
SB30X- <u>B</u> XX-X	Rp 3 (3 - 11 BSP parallel)
Air Inlet (female)	3/4 - 14 N.P.T.
Air Exhaust (female)	1/8 - 27 N.P.T.
Weight	
SB30X- <u>X</u> AX-X	41 lbs (18.6 kgs)
SB30X- <u>X</u> CX-X	94 lbs (42.6 kgs)
SB30X- <u>X</u> SX-X	96 lbs (43.5 kgs)
Pulsation Dampener Service Kit	637330-3X

SB30X - XXX -

637330 - 3

Diaphragm material

EXAMPLE: Model #SB30A-BAP-G
Pulsation Dampener Service Kit is 637330-3G

PERFORMANCE

Maximum Air Inlet Pressure	120 p.s.i.g. (8.3 bar)
Maximum Material Inlet Pressure	120 p.s.i.g. (8.3 bar)
Maximum Temperature Limits (diaphragm / seal material)	
E.P.R. / EPDM	-60° to 280° F (-51° to 138° C)
Nitrile	10° to 180° F (-12° to 82° C)
Santoprene®	-40° to 225° F (-40° to 107° C)
PTFE	40° to 225° F (4° to 107° C)
Viton®	-40° to 350° F (-40° to 177° C)
Maximum Fluid Volume	367 in. ³ (6.01 lit.)

3" Pump % Reduction in Pulsation

Back Pressure (P.S.I.)	% Reduction in Pulsation			
	40	60	80	100
5	60%	60%	60%	60%
75	60%	65%	60%	60%
125	60%	65%	60%	50%
150	60%	65%	60%	50%
200	60%	65%	60%	50%

INGERSOLL RAND COMPANY LTD

209 NORTH MAIN STREET - BRYAN, OHIO 43506

☎ (800) 495-0276 • FAX(800) 892-6276

www.ingersollrandproducts.com

© 2010

CCN 99834111

ARO

IR Ingersoll Rand
Industrial Technologies